

FS24-500

Description:

The FS24-500 is a dual primary and dual secondary, split bobbin design which operates with either a parallel input of 115V or a series input of 230V. The output voltage will be either 24.0V with a center-tap under a 0.5A load with the secondaries wired in series, or 12.0V under a 1.0A load with the secondaries wired in parallel. The split bobbin design eliminates the need for costly electrostatic shielding.

Electrical Specifications (@25C)

1. Maximum Power: 12.0VA
2. Primary: Series: 230V; Parallel: 115V
3. Secondary: Series: 24.0V CT@ 0.5A; Parallel: 12.0V @ 1.0A
4. Voltage Regulation: 25% TYP @ full load to no load
5. Temperature Rise: 25C TYP
6. Hipot tested 100% at 2500 VRMS

Construction:

Three flange bobbin construction with primaries and secondaries wound side by side for low capacitive coupling.

Agency File:

UL: File E53148, UL 5085-2 (506), Class B General Purpose Transformer, cUL: File E53148, UL 5085-2 (506), Class B General Purpose Transformer, Canadian Use (CSA 22.2, No.66.2-06)

This model is also available in Class 2, UL 5085-3 (1585) version as [FS24-500-C2](#)



Dimensions:

Units in inches.

| H | W | L | A | B | C | D | E | F |
|-------|-------|-------|-------|-------|-------|-------|-------|-------|
| 1.437 | 1.562 | 1.875 | 0.300 | 0.400 | 1.410 | 0.041 | 0.020 | 0.234 |

Weight: 0.70 lbs

Schematic:

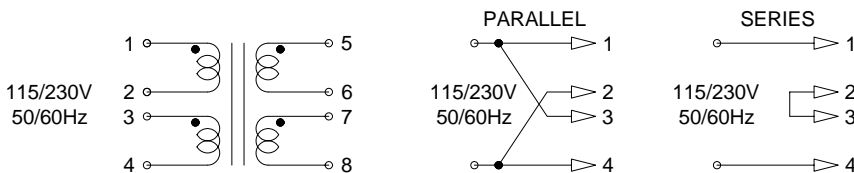

RoHS Compliance: As of manufacturing date February 2005, all standard products meet the requirements of 2002/95/EC, known as the RoHS initiative.

As of April 7, 2008, UL standards 506 and 1585 will be migrated to UL 5085-2 and 5085-3, respectively.

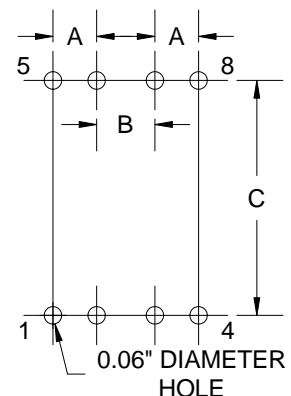
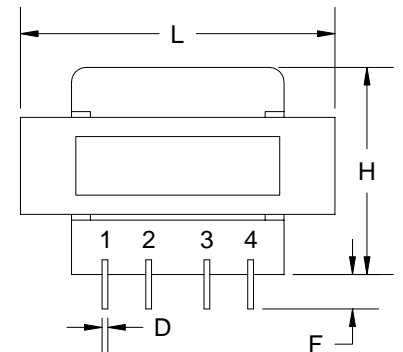
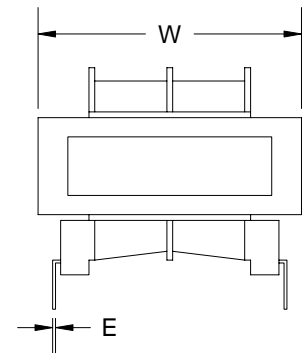
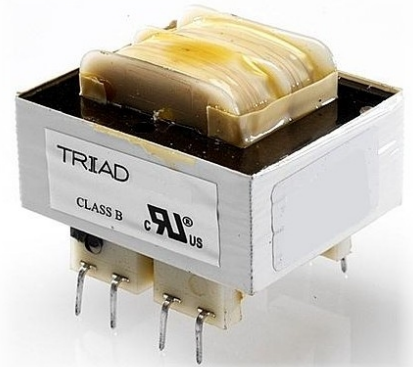

Board Layout

Power Transformers

Class B
UL Recognized



UL File E53148

PC Mount: Split Pack™

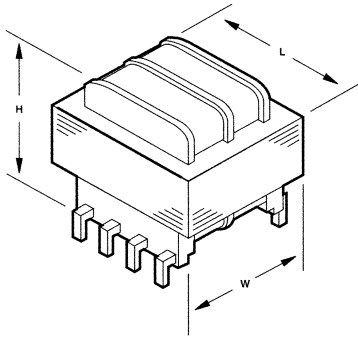

:: Description

The Triad Split Pack split bobbin transformer is an extremely versatile tool for PC board applications. Split Pack transformers are nonconcentrically wound -- with primaries and secondaries side-by-side. Unlike the secondary-on-top-of-primary designs of standard PC board transformers, the split bobbin winding and low capacitive coupling eliminate costly electrostatic shielding. It is offered in a dual secondary configuration with either single or dual primaries.

:: Specifications

Primary: 115 V, 50/60 Hz | **VA Ranges:** 1.1 to 36.0

Secondary: Series - 10 to 120 V; Parallel - 5 to 60 V

:: Split Pack

| Section | Single Primary 6 Pin | Dual Primary 8 Pin | VA | Secondary | | Dimensions | | | | | | | Wt. Lbs. |
|----------|-------------------------|-----------------------|-------------------|-------------------|----------------|-----------------|-------------|--------|--------|-------|--------|-------|-------------|
| | | | | Series | Parallel | H | W | L | ML | A | B | C | |
| A | F10-110 | FS10-110 | 1.1 | 10.0V CT @ 0.11A | 5.0V @ 0.22A | 15/16 | 1 1/8 | 1 1/8 | • | 0.250 | 0.250 | 1.20 | 0.17 |
| | F12-090 | FS12-090 | | 12.6V CT @ 0.09A | 6.3V @ 0.18A | | | | | | | | |
| | F16-070 | FS16-070 | | 16.0V CT @ 0.07A | 8.0V @ 0.14A | | | | | | | | |
| | F20-055 | FS20-055 | | 20.0V CT @ 0.055A | 10.0V @ 0.11A | | | | | | | | |
| | F24-045 | FS24-045 | | 24.0V CT @ 0.045A | 12.0V @ 0.09A | | | | | | | | |
| | F28-040 | FS28-040 | | 28.0V CT @ 0.040A | 14.0V @ 0.08A | | | | | | | | |
| | F36-030 | FS36-030 | | 36.0V CT @ 0.03A | 18.0V @ 0.06A | | | | | | | | |
| | F48-023 | FS48-023 | | 48.0V CT @ 0.023A | 24.0V @ 0.046A | | | | | | | | |
| | F56-020 | FS56-020 | | 56.0V CT @ 0.02A | 28.0V @ 0.04A | | | | | | | | |
| | F120-010 | FS120-01 | | 120.0V CT @ 0.01A | 60.0V @ 0.02A | | | | | | | | |
| | B | F10-250 | | FS10-250 | 2.5 | | | | | | | | |
| F12-200 | | FS12-200 | 12.6V CT @ 0.2A | 6.3V @ 0.4A | | | | | | | | | |
| F16-150 | | FS16-150 | 16.0V CT @ 0.15A | 8.0V @ 0.3A | | | | | | | | | |
| F20-120 | | FS20-120 | 20.0V CT @ 0.12A | 10.0V @ 0.24A | | | | | | | | | |
| F24-100 | | FS24-100 | 24.0V CT @ 0.1A | 12.0V @ 0.2A | | | | | | | | | |
| F28-85 | | FS28-85 | 28.0V CT @ 0.085A | 14.0V @ 0.17A | | | | | | | | | |
| F36-65 | | FS36-65 | 36.0V CT @ 0.065A | 18.0V @ 0.13A | | | | | | | | | |
| F48-050 | | FS48-050 | 48.0V CT @ 0.05A | 24.0V @ 0.1A | | | | | | | | | |
| F56-045 | | FS56-045 | 56.0V CT @ 0.045A | 28.0V @ 0.09A | | | | | | | | | |
| F120-020 | | FS120-02 | 120.0V CT @ 0.02A | 60.0V @ 0.04A | | | | | | | | | |
| C | | F10-600 | FS10-600 | 6.0 | | 10.0V CT @ 0.6A | 5.0V @ 1.2A | 1 1/16 | 1 1/16 | 1 1/8 | 1 1/16 | 0.250 | 0.350 |
| | F12-500 | FS12-500 | 12.6V CT @ 0.5A | | 6.3V @ 1.0A | | | | | | | | |
| | F16-400 | FS16-400 | 16.0V CT @ 0.4A | | 8.0V @ 0.8A | | | | | | | | |
| | F20-300 | FS20-300 | 20.0V CT @ 0.3A | | 10.0V @ 0.6A | | | | | | | | |
| | F24-250 | FS24-250 | 24.0V CT @ 0.25A | | 12.0V @ 0.5A | | | | | | | | |
| | F28-200 | FS28-200 | 28.0V CT @ 0.2A | | 14.0V @ 0.4A | | | | | | | | |
| | F36-170 | FS36-170 | 36.0V CT @ 0.17A | | 18.0V @ 0.34A | | | | | | | | |
| | F48-125 | FS48-125 | 48.0V CT @ 0.125A | | 24.0V @ 0.25A | | | | | | | | |
| | F56-110 | FS56-110 | 56.0V CT @ 0.11A | | 28.0V @ 0.22A | | | | | | | | |
| | F120-050 | FS120-05 | 120.0V CT @ 0.05A | | 60.0V @ 0.1A | | | | | | | | |
| | D | F10-1200 | FS10-1200 | | 12.0 | 10.0V CT @ 1.2A | 5.0V @ 2.4A | | | | | | |
| F12-1000 | | FS12-1000 | 12.6V CT @ 1.0A | 6.3V @ 2.0A | | | | | | | | | |
| F16-800 | | FS16-800 | 16.0V CT @ 0.8A | 8.0V @ 1.6A | | | | | | | | | |
| F20-600 | | FS20-600 | 20.0V CT @ 0.6A | 10.0V @ 1.2A | | | | | | | | | |
| F24-500 | | FS24-500 | 24.0V CT @ 0.5A | 12.0V @ 1.0A | | | | | | | | | |
| F28-420 | | FS28-420 | 28.0V CT @ 0.42A | 14.0V @ 0.84A | | | | | | | | | |
| F36-350 | | FS36-350 | 36.0V CT @ 0.35A | 18.0V @ 0.7A | | | | | | | | | |
| F48-250 | | FS48-250 | 48.0V CT @ 0.25A | 24.0V @ 0.5A | | | | | | | | | |
| F56-220 | | FS56-220 | 56.0V CT @ 0.22A | 28.0V @ 0.44A | | | | | | | | | |
| F120-100 | | FS120-100 | 120.0V CT @ 0.1A | 60.0V @ 0.2A | | | | | | | | | |
| E | | F10-2000 | FS10-2000 | 20.0 | | 10.0V CT @ 2.0A | 5.0V @ 4.0A | 1 1/16 | 1 1/8 | 2 1/4 | 1 1/2 | 0.30 | 0.40 |
| | F12-1600 | FS12-1600 | 12.6V CT @ 1.6A | | 6.3V @ 3.2A | | | | | | | | |
| | F16-1250 | FS16-1250 | 16.0V CT @ 1.25A | | 8.0V @ 2.5A | | | | | | | | |
| | F20-1000 | FS20-1000 | 20.0V CT @ 1.0A | | 10.0V @ 2.0A | | | | | | | | |
| | F24-800 | FS24-800 | 24.0V CT @ 0.8A | | 12.0V @ 1.6A | | | | | | | | |
| | F28-700 | FS28-700 | 28.0V CT @ 0.7A | | 14.0V @ 1.4A | | | | | | | | |
| | F36-550 | FS36-550 | 36.0V CT @ 0.55A | | 18.0V @ 1.1A | | | | | | | | |
| | F48-400 | FS48-400 | 48.0V CT @ 0.4A | | 24.0V @ 0.8A | | | | | | | | |
| | F56-350 | FS56-350 | 56.0V CT @ 0.35A | | 28.0V @ 0.7A | | | | | | | | |
| | F120-160 | FS120-160 | 120.0V CT @ 0.16A | | 60.0V @ 0.32A | | | | | | | | |

CT = Center Tap

Power Transformers

PC Mount: Split Pack™

| Section | Single Primary 6 Pin | Dual Primary 8 Pin | VA | Secondary | | Dimensions | | | | | | Wt. Lbs. | |
|---------|-------------------------|-----------------------|------|------------------|--------------|--------------------------------|--------------------------------|--------------------------------|----|------|------|-------------|-----|
| | | | | Series | Parallel | H | W | L | ML | A | B | | C |
| A | F10-3600 | FS10-3600 | 36.0 | 10.0V CT @ 3.6A | 5.0V @ 7.2A | 1 ¹ / ₁₆ | 2 ³ / ₁₆ | 2 ³ / ₁₆ | * | 0.40 | 0.40 | 1.850 | 1.1 |
| | F12-2850 | FS12-2850 | | 12.6V CT @ 2.85A | 6.3V @ 5.7A | | | | | | | | |
| | F16-2250 | FS16-2250 | | 16.0V CT @ 2.25A | 8.0V @ 4.5A | | | | | | | | |
| | F20-1800 | FS20-1800 | | 20.0V CT @ 1.8A | 10.0V @ 3.6A | | | | | | | | |
| | F24-1500 | FS24-1500 | | 24.0V CT @ 1.5A | 12.0V @ 3.0A | | | | | | | | |
| | F28-1300 | FS28-1300 | | 28.0V CT @ 1.3A | 14.0V @ 2.6A | | | | | | | | |
| | F36-1000 | FS36-1000 | | 36.0V CT @ 1.0A | 18.0V @ 2.0A | | | | | | | | |
| | F48-750 | FS48-750 | | 48.0V CT @ 0.75A | 24.0V @ 1.5A | | | | | | | | |
| | F56-650 | FS56-650 | | 56.0V CT @ 0.65A | 28.0V @ 1.3A | | | | | | | | |
| | F120-300 | FS120-300 | | 120.0V CT @ 0.3A | 60.0V @ 0.6A | | | | | | | | |

* 36 VA size has 4 mtg. holes on 2³/₁₆ x 1¹/₄ centers. CT = Center Tap

:: Outline Dimensions

Technical Notes

- Hi-pot tested at 2,500 VRMS.
- PC terminal pin spacing for accurate placement.
- 115 V connect primary in parallel.
230 V connect primary in series.

4. **Series Connections:** Primary - Input 1 & 4
Connect 2 & 3
Secondary - Input 5 & 8
Connect 6 & 7

5. **Parallel Connections:** Primary - Input 1 & 2
Connect 1 & 3, 2 & 4
Secondary - Input 5 & 8
Connect 5 & 7, 6 & 8

6. For single primary, omit pins 2 and 3.

